

Pressure Independent Control Valve (DN 65-250)

NexusValve
Vivax Plus



NexusValve
Vivax Plus

Table of contents

Chapter NexusValve Vivax Plus DN 65-250

1.	Safety instructions	4
1.1	Rules/regulations	4
1.2	Intended use	5
1.3	Initial operation	5
1.4	Working on the system	5
1.5	Liability	5
2.	Introduction	6
2.1	Description	6
2.2	Benefits	6
2.3	Design	7
2.4	Flow setting	8
2.5	Differential pressure verification	8
2.6	Flow control accuracy	8
2.7	Operation	9
2.8	Mounting	10
2.9	Wiring	11
3.	Applications	12
4.	Product data sheet	14
4.1	Product finder	14
4.2	NexusValve Vivax Plus DN 65-250	15
4.2.1	DN65/80L, DN65/80S, DN65/80H flange/flange	15
4.2.2	DN80/100L, DN80/100S, DN80/100H flange/flange	17
4.2.3	DN125/150S, DN125/150H flange/flange	19
4.2.4	DN200/250 flange/flange	21
4.3	Flanges for NexusValve Vivax Plus	23
5.	Sizing example	24
5.1	General specifications NexusValve Vivax Plus DN65-250	26

1. Safety instructions

Please read the instructions carefully before installation

The installation and initial operation of the assembly may be carried out only by an authorised specialist company. Prior to starting work, familiarise yourself with all parts and how they are handled. The application examples in these operating instructions are ideas sketched out. Local laws and regulations have to be observed.

Target group:

These instructions are intended for authorised specialists exclusively. Work on the heating system, the potable water as well as gas and power network may be carried out by specialists only.



Please follow these safety instructions carefully in order to avoid hazards and damage to people and property.

1.1 Rules/regulations

Please observe the applicable accident prevention regulations, the environmental legislation and the legal rules for mounting, installation and operation. Moreover, please observe the appropriate guidelines of German standard DIN, EN, DVGW, VDI and VDE (including lightning protection) as well as all current relevant country-specific standards, laws and regulations. Old and newly enforced regulations and standards shall apply, if they are relevant for the individual case. Moreover, the regulations of your local energy supply company have to be observed.

Electrical connection:

Electrical wiring work may be carried out by qualified electricians only. The VDE regulations and the specifications of the relevant energy supply company have to be met.

Excerpt:

Installation and construction of heat generators as well as the drinking water heaters:

DIN EN 4753, Part 1: Water heater and water heating plants for potable and process water.

DIN EN 12828: Heating systems in buildings.

Allowed medium (cf. DIN EN 12828): Heating water according to VDI 2035 (non-corrosive).

DIN 18 421: Insulation work on technical plants

AV B Wa s V Regulations concerning the general conditions for the supply with water

DIN EN 806 ff.: Technical rules for potable water installation

DIN 1988 ff.: Technical rules for potable water installation (national addition)

DIN EN 1717: Protection of potable water against contaminations

DIN 4751: Safety equipment

Electrical connection:

VDE 0100: Erection of electrical equipment, grounding, protective conductor, potential equalisation conductor.

VDE 0701: Repair, modification and testing of electrical devices.

VDE 0185: General aspects on the erection of lightning protection systems.

VDE 0190: Main potential equalisation of electrical plants.

VDE 0855: Installation of antenna plants (shall apply mutatis mutandis).

Additional remarks:

VDI 6002 Sheet 1: General principles, system technology and use in house building

VDI 6002, Sheet 2: Use in students' hostels, retirement homes, hospitals, indoor swimming pools and on camping facilities

Caution:

Prior to any electrical wiring work on pumps and controls, these modules have to be disconnected from voltage correctly.

1.2 Intended use

Inexpert installation as well as use for a purpose not intended of the assembly shall rule out all warranty claims.

All shut-off valves may be closed by an approved specialist only in case of servicing as otherwise the safety valves are not effective.



Do not modify the electrical components, the construction or the hydraulic components! You will impair the safe function of the plant otherwise.

1.3 Initial operation

Prior to the initial operation, the plant has to be tested for tightness, correct hydraulic connection as well as accurate and correct electrical connection. In addition, the plant has to be flushed correctly and/as required in keeping with German standard DIN 4753. The initial operation has to be carried out by a trained specialist, which has to be recorded in writing. In addition, the settings have to be put down in writing. The technical documentation has to be available at the device.

1.4 Working on the system

The plant has to be de-energised and to be checked for the absence of voltage (such as on the separate fuse or a master switch). Secure the plant against unintentional restart.

(If gas is used as fuel, close the gas shut-off valve and secure against unintentional opening.) Repair work on component parts with a safety-relevant function is impermissible.

1.5 Liability

We reserve all copyrights for this document. Wrongful use, in particular reproduction and forwarding to third parties shall not be permitted.

These installation and operating instructions shall have to be handed to the customer. The executing and/or authorised tradesperson (such as fitter) shall have to explain the function and operation of the plant to the customer in an intelligible manner.

2. Introduction

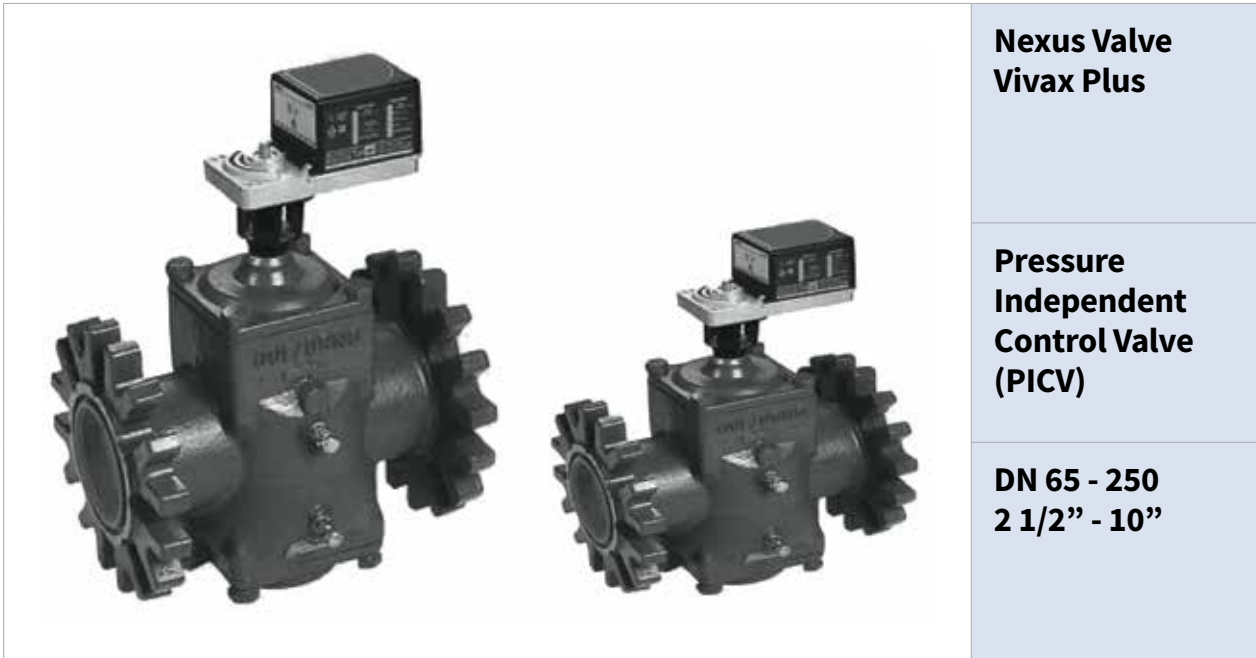

2.1 Description

The NexusValve Vivax Plus is a combined pressure independent flow limiter and control valve. It maintains constant flow independent of pressure changes in water-based cooling or heating systems.

The NexusValve Vivax Plus combines an automatic flow limiter and a 2-way control valve. With full control authority the valve reacts instantly and adjusts the flow as signalled by the Building Management System (BMS), a room thermostat or a ventilation air temperature controller.

2.2 Benefits

- Automatic balancing
- Perfect flow control - 100% valve authority
- No straight piping required - installation directly on bends and reducers possible
- No overflows - no unnecessary energy consumption
- Optional fail safe function
- Better thermal comfort
- High flow control accuracy: from +/- 2% to +/-5%
- Commissioning not needed
- Easy valve selection
- Low installation costs because of two in one construction - motorized valve and automatic flow limiter
- Precise pump tuning when verifying differential pressure on measuring points for energy saving
- System extension or repair possible without upsetting flow in the operating terminal units

2.3 Design

The NexusValve Vivax Plus consists of a pre-setting unit acting like a manual balancing valve and being at the same time a two-way valve, electromechanical actuator with DIP switches used for setting the sizing (maximum) flow, differential pressure regulator, measuring points and the housing.

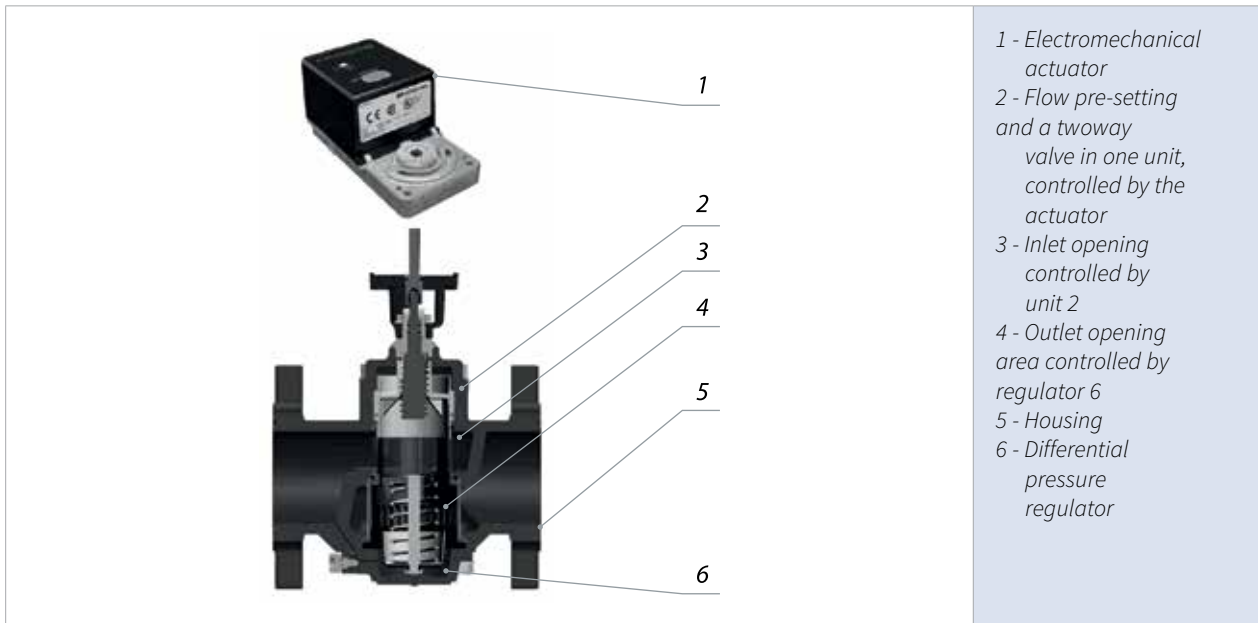

The actuator is used for setting the sizing flow by the use of the DIP switches. It also operates the pre-setting unit providing a function of a two-way valve which controls flow in reference to load conditions. When the actuator changes the position of the two-way valve in response to a signal from the BMS system, a room thermostat or a ventilation air temperature controller, a new inlet opening area is established and a new flow achieved. The NexusValve Vivax Plus can control any flow that is not greater than the flow programmed by the DIP switches.

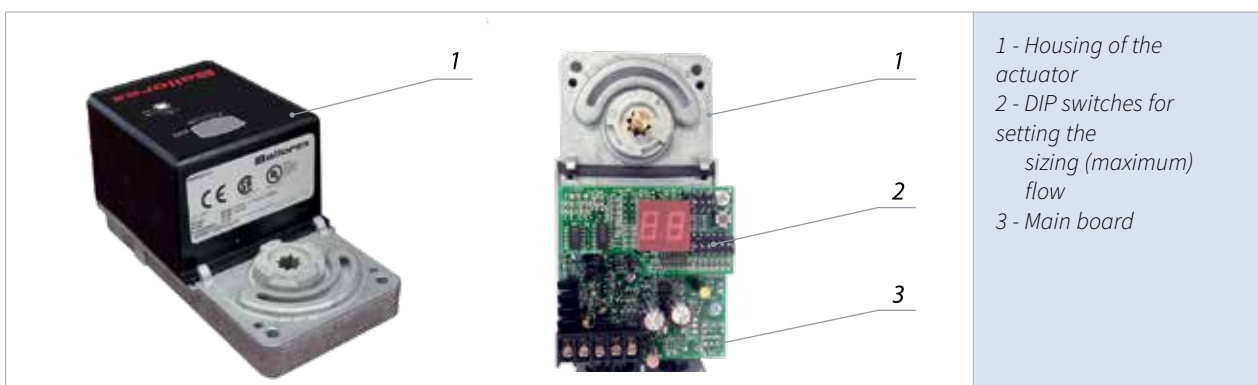

The integrated differential pressure regulator maintains a constant pressure loss over the pre-setting unit. The required flow is thereby kept constant regardless of pressure fluctuations in the system. This ensures 100% control authority of the valve in all situations.

2. Introduction

2.4 Flow setting

The maximum flow setting is achieved by turning the DIP switches to the ON or OFF position according to the tables in the technical description paragraph. By doing so the actuator moves the two-way valve to a position which corresponds to the requested sizing flow setting. This flow can never be exceeded regardless of pressure fluctuations.

2.5 Differential pressure verification

To ensure that the NexusValve Vivax Plus maintains the flow on a constant level the integrated differential pressure regulator must operate within its working range.

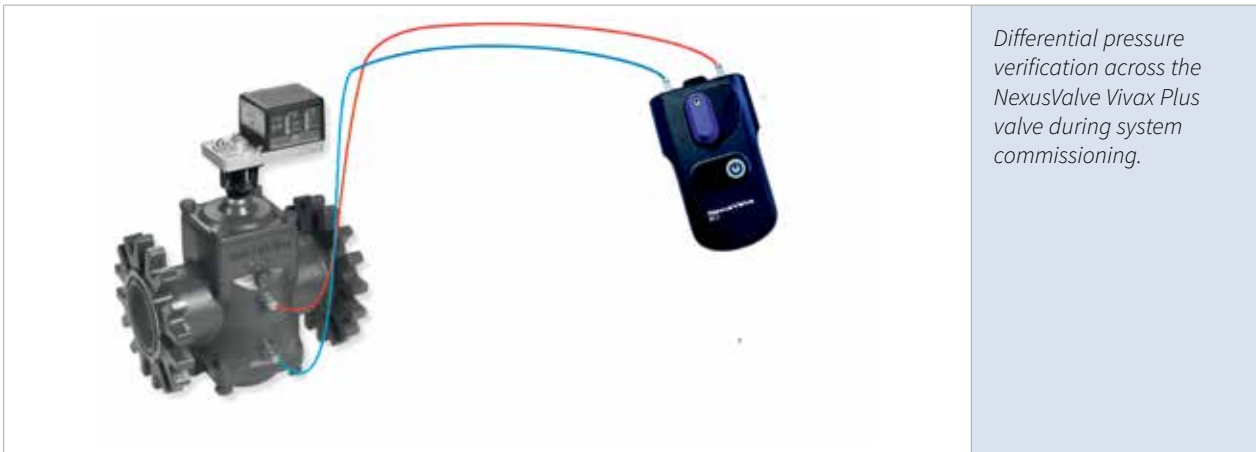

The differential pressure is measured by connecting a balancing computer to the measuring points of the valve. Once it has been confirmed that there is enough differential pressure over the NexusValve Vivax Plus valve, the sizing flow will never be exceeded.

2.6 Flow control accuracy

When set to a given flow, all valves based on the principle of dynamic balancing have a certain inaccuracy. Within the valve operating pressure range the real flow can deviate from the set design flow. In practise this means that because of pressure fluctuations in the system, the actual flow through the valve differs from what it was set to be.

This typically occurs from hysteresis and the desire to have a low starting pressure which is required for the differential pressure regulator in the valve to stabilize the flow.

The starting pressure of the index valve contributes to the total system pressure loss and therefore influences pump dimensioning.

The built-in differential pressure regulator stabilizes the flow on the NexusValve Vivax Plus when the pressure loss over the valve is within 30kPa to 600kPa. In case of the high flow versions of NexusValve Vivax Plus the required differential pressure ranges from 35-600kPa and from 50-600kPa

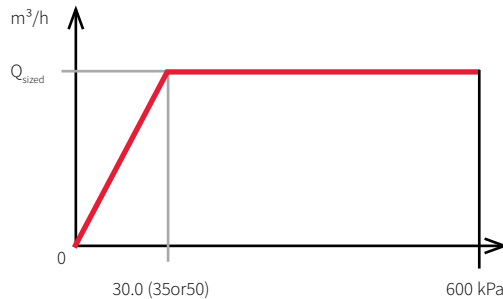

The regulator ensuring constant differential pressure over the pre-setting and two-way valve unit requires minimum 30.0 (35 or 50) kPa and maximum 600 kPa pressure loss across the complete valve to operate properly. Within this pressure loss range the valve will maintain a constant flow (Q_{sized})

The accuracy of flow control of the NexusValve Vivax Plus valve is the greater value of either $\pm 2\%$ of maximum flow or $\pm 5\%$ of controlled flow.

2.7 Operation

A balancing procedure is not required when using NexusValve Vivax Plus valves. The valves are simply set to the required flow rate and will compensate for pressure fluctuations in the system. The hydraulic balance in the system is thereby ensured.

When all valves are set at the required flow rate, the pump head is then minimized to avoid unnecessary energy consumption. The pump head is decreased to the optimal point where the pump delivers only as much pressure as the index valve needs to work properly.

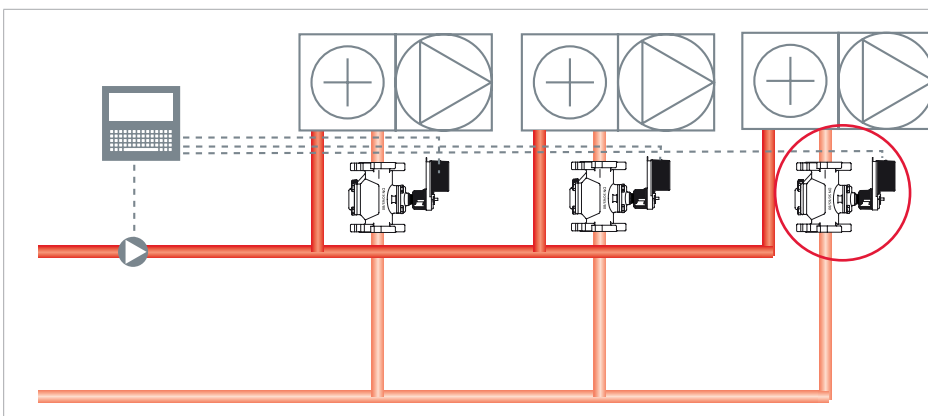

Indication of the index valve in a system with air handling units balanced by NexusValve Vivax Plus valves.

The optimal pump setting is easily found in a system with NexusValve Vivax Plus valves. The pump is set to its maximum capacity during setting of the NexusValve Vivax Plus valves. After the setting of all valves has been completed a balancing computer is connected to the index valve, which is the system valve with the least differential pressure available. Typically this would be the most remote valve from the pump.

2. Introduction

The pump head is then reduced until the pressure loss over the index valve is equal to the minimum required values of 30, 35 or 50kPa respectively, depending on the flow version of the valve. Hydraulic balance is established and the pump head is kept at a minimum.

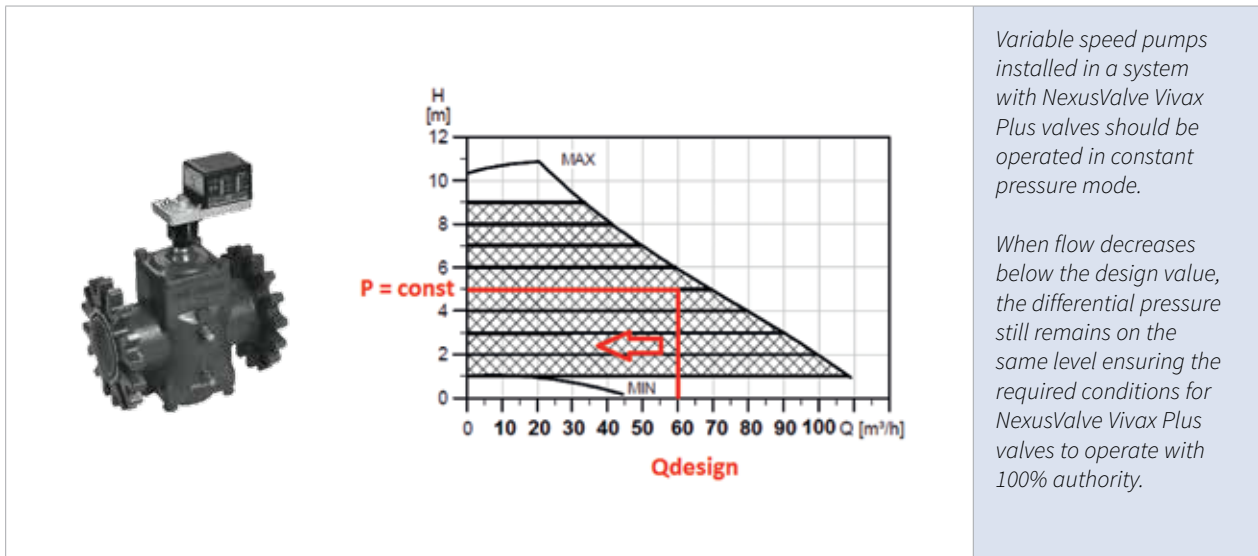

When using a variable speed pump it is recommended to operate it in a constant differential pressure mode. This ensures that the flow will be adjusted according to the current load demand and that the constant pressure level will provide the required conditions for the differential pressure regulator within NexusValve Vivax Plus valves to operate properly.

2.8 Mounting

The o-rings must be in place in the grooves. It is recommended to grease the o-rings with silicone before installation. The NexusValve Vivax Plus is mounted between flanges with provided studs, bolts and nuts. The arrow on the NexusValve Vivax Plus housing indicates the flow direction to be respected. No straight piping is required – the NexusValve Vivax Plus valve can be mounted directly on bends and flexible pipes, etc. The actuator should be above the valve spindle. Due to condensation risk the actuator must not be below the valve spindle. The actuator must not be installed below the valve. Flow setting is carried out by turning the DIP switches in the actuator to the required position. To check if the valve is in the dynamic flow control mode the differential pressure can be measured.

2.9 Wiring

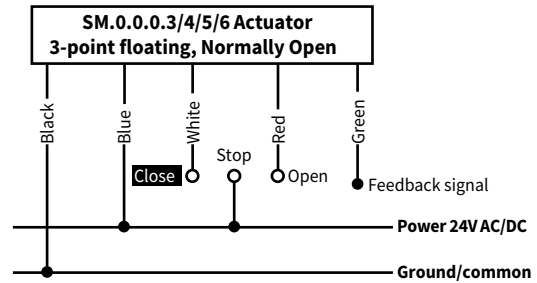
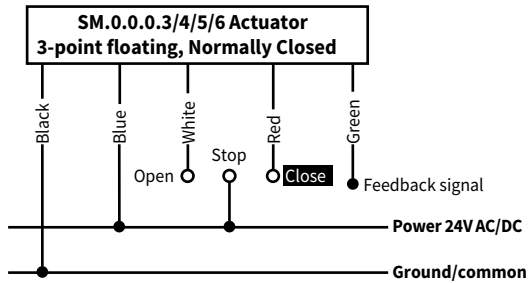
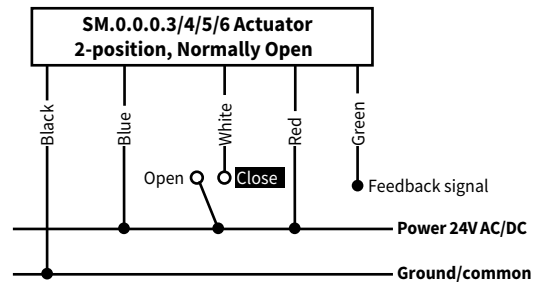
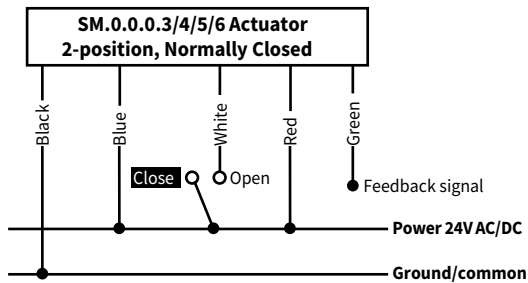
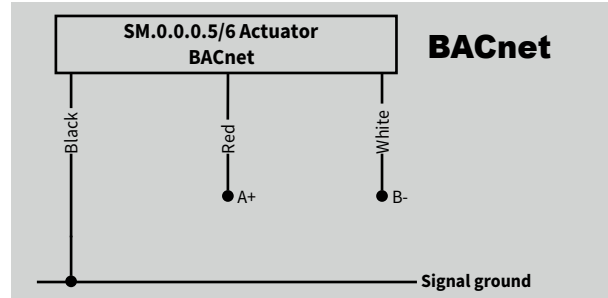
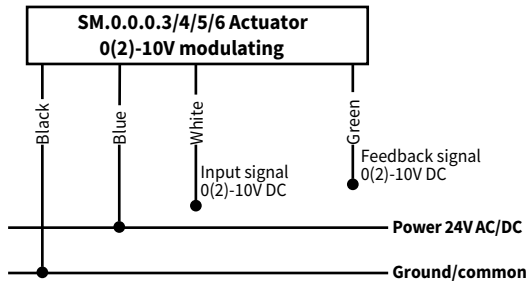

Note: If feedback signal is not required, leave green wire detached.

3. Applications

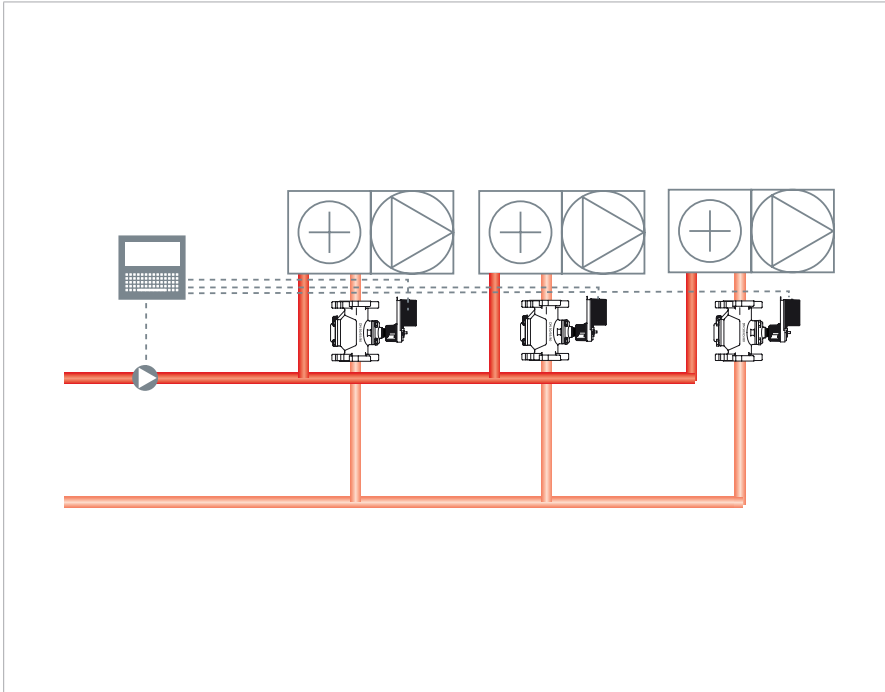

*Application 1
System with air handling units*

The NexusValve Vivax Plus valves are installed at air handling units to control flow in reference to the required air temperature.

The maximum flow limitation is done by the DIP switch setting which is required to ensure the hydronic balance in sizing conditions.

If less flow is required, the actuators controlling NexusValve Vivax Plus will limit the flow in reference to the signal from the control unit monitoring air temperature in air handling units.

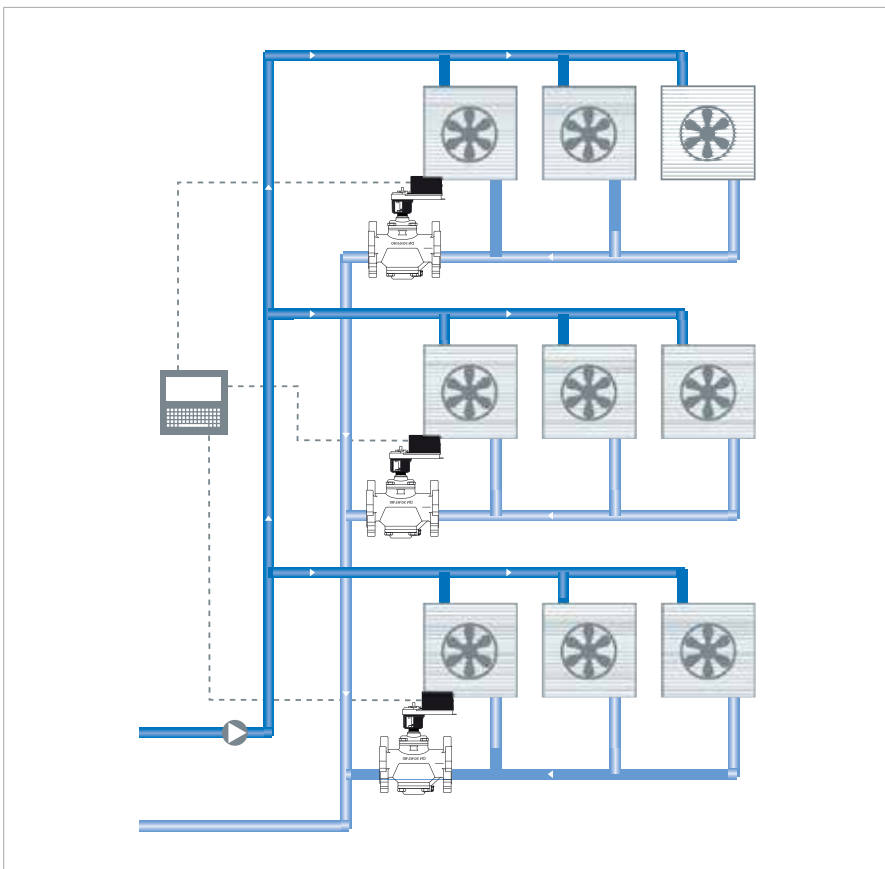

*Application 2
System with several fan coils*

The NexusValve Vivax Plus valves are used to control flow in branches with several fan coils.

When a few fan coils are installed in a single room, one valve can control flow to all of them.

NexusValve Vivax Plus is in this instance controlled by a BMS or a room thermostat and provides the required flow in reference to the room air temperature.

The maximum flow limitation is done by the DIP switch setting which is required to ensure the hydronic balance in sizing conditions.

NexusValve Vivax Plus

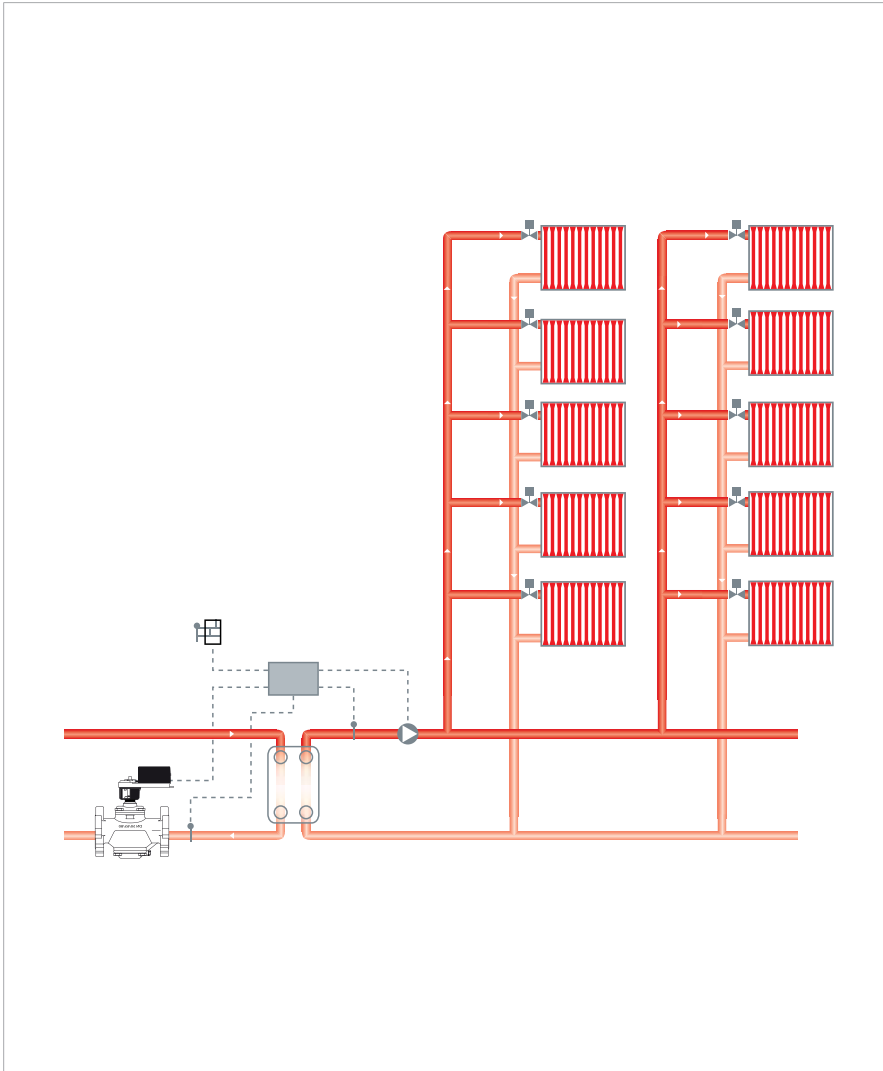

Application 3 District heating system - heat exchange station

The NexusValve Vivax Plus valves are used to control flow in heat exchange stations in heating and cooling systems.

The maximum flow limitation is done by the DIP switch setting which is required to ensure the hydronic balance in sizing conditions.

The required temperature of water in the secondary side of the system is achieved by controlling flow on NexusValve Vivax Plus. The control unit or a BMS system provides a signal changing the position of the two-way valve in NexusValve Vivax Plus and thus assuring the required flow in reference to the outdoor air temperature.

Each time a new flow is provided, the integrated in NexusValve Vivax Plus differential pressure regulator makes it is kept constant regardless of pressure fluctuations in the system.

4. Product data sheet

4.1 Product finder

Flow range		Dimension
l/s	l/h	
1.48-4.16	5310-15000	DN65/80L
2.57-7.15	9240-25700	DN65/80S
3.55-9.88	12800-35600	DN65/80H
3.49-9.38	12600-33800	DN80/100L
4.73-14.2	17000-51000	DN80/100S
3.68-20.2	13300-72700	DN80/100H
6.48-23.3	23300-83800	DN125/150S
7.10-29.5	25600-106000	DN125/150H
9.21-76.8	33100 - 277000	DN200/250

4. Product data sheet

4.2 NexusValve Vivax Plus DN 65-250

4.2.1 DN65/80L, DN65/80S, DN65/80H flange/flange

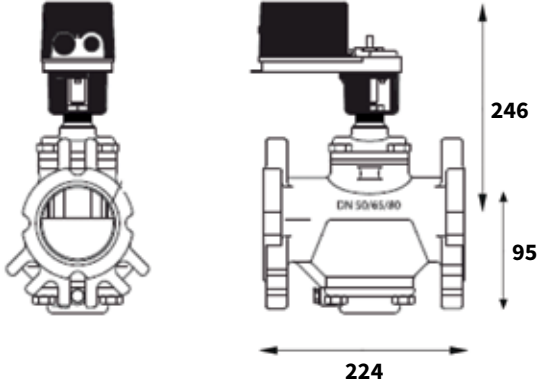
Dimensions	Specifications
	<p>Max. temperature 120°C Min. temperature -20°C Ambient Temperature -10°C to 50°C Max. pressure PN40 (10, 16, 25) Operating pressure 30, 35 – 600 kPa Marking on valve DN, flow direction Connection Universal flange connections for ISO and ANSI flanges Valve housing Ductile iron ASTM A536-65T, class 65-45-18 Diaphragm Hydrogenated acrylonitrile-butadiene-rubber EPDM O-Rings Internal metal components Stainless steel</p>

Valve	Article	Dimensions	Nom. Inch	Kvm m ³ /h	Flow range	
					l/h	l/s
	MN80597.030	DN65/80L	2" / 2½"	24	5310-15000	1.48-4.16
	MN80597.031	DN65/80S	2" / 2½"	39.5	9240-25700	2.57-7.15
	MN80597.032	DN65/80H	2" / 2½"	39.5	12800-35600	3.55-9.88

Note!

Delivery comprises the valve, actuator, two 16 mm studs and four 16 mm bolts with nuts for mounting the valve between flanges. Fail safe function is provided on request.

Performance data	
Maximum shut-off pressure	600kPa
Maximum leakage	Below 0.2% of the Kvs value
Flow control accuracy	The greater value of either ±2% of maximum flow or ±5% of controlled flow
Control characteristic	Linear

Note!

The Kvs value must be used only for the leakage rate calculation and not valve sizing. The selection of the valve must be based on the flow table only.

4.2.1.1 Flow and DIP switch setting table

Flow Rate						Maximum Flow Rate DIP Switch Settings						Stem Rotations From Closed
30-600 kPaD		30-600 kPaD		35-600 kPaD								
DN 65/80L		DN 65/80S		DN 65/80H								
l/s	l/h	l/s	l/h	l/s	l/h	1	2	3	4	5	6	Rotations
1.48	5310	2.57	9240	3.55	12800	ON	ON	ON	ON	ON	ON	1.0
1.58	5700	2.81	10100	3.85	13900	OFF	ON	ON	ON	ON	ON	1.1
1.69	6080	3.05	11000	4.13	14900	ON	OFF	ON	ON	ON	ON	1.2
1.79	6460	3.27	11800	4.41	15900	OFF	OFF	ON	ON	ON	ON	1.3
1.90	6830	3.48	12500	4.67	16800	ON	ON	OFF	ON	ON	ON	1.4
2.00	7190	3.69	13300	4.92	17700	OFF	ON	OFF	ON	ON	ON	1.5
2.09	7540	3.88	14000	5.16	18600	ON	OFF	OFF	ON	ON	ON	1.6
2.19	7880	4.06	14600	5.38	19400	OFF	OFF	OFF	ON	ON	ON	1.7
2.28	8210	4.23	15200	5.60	20200	ON	ON	ON	OFF	ON	ON	1.8
2.37	8540	4.39	15800	5.81	20900	OFF	ON	ON	OFF	ON	ON	1.9
2.46	8860	4.54	16300	6.01	21600	ON	OFF	ON	OFF	ON	ON	2.0
2.55	9170	4.68	16900	6.19	22300	OFF	OFF	ON	OFF	ON	ON	2.1
2.63	9470	4.82	17300	6.37	22900	ON	ON	OFF	OFF	ON	ON	2.2
2.71	9770	4.94	17800	6.54	23600	OFF	ON	OFF	OFF	ON	ON	2.3
2.79	10100	5.06	18200	6.70	24100	ON	OFF	OFF	OFF	ON	ON	2.4
2.87	10300	5.17	18600	6.86	24700	OFF	OFF	OFF	OFF	ON	ON	2.5
2.94	10600	5.28	19000	7.00	25200	ON	ON	ON	ON	OFF	ON	2.6
3.02	10900	5.37	19300	7.14	25700	OFF	ON	ON	ON	OFF	ON	2.7
3.09	11100	5.47	19700	7.27	26200	ON	OFF	ON	ON	OFF	ON	2.8
3.16	11400	5.55	20000	7.40	26600	OFF	OFF	ON	ON	OFF	ON	2.9
3.22	11600	5.63	20300	7.52	27100	ON	ON	OFF	ON	OFF	ON	3.0
3.29	11800	5.70	20500	7.63	27500	OFF	ON	OFF	ON	OFF	ON	3.1
3.35	12100	5.77	20800	7.74	27900	ON	OFF	OFF	ON	OFF	ON	3.2
3.41	12300	5.84	21000	7.84	28200	OFF	OFF	OFF	ON	OFF	ON	3.3
3.46	12500	5.90	21200	7.94	28600	ON	ON	ON	OFF	OFF	ON	3.4
3.52	12700	5.95	21400	8.03	28900	OFF	ON	ON	OFF	OFF	ON	3.5
3.57	12900	6.01	21600	8.12	29200	ON	OFF	ON	OFF	OFF	ON	3.6
3.62	13000	6.06	21800	8.20	29500	OFF	OFF	ON	OFF	OFF	ON	3.7
3.67	13200	6.10	22000	8.28	29800	ON	ON	OFF	OFF	OFF	ON	3.8
3.72	13400	6.15	22100	8.36	30100	OFF	ON	OFF	OFF	OFF	ON	3.9
3.76	13500	6.19	22300	8.44	30400	ON	OFF	OFF	OFF	OFF	ON	4.0
3.80	13700	6.23	22400	8.51	30600	OFF	OFF	OFF	OFF	OFF	ON	4.1
3.84	13800	6.27	22600	8.58	30900	ON	ON	ON	ON	ON	OFF	4.2
3.88	14000	6.31	22700	8.65	31100	OFF	ON	ON	ON	ON	OFF	4.3
3.91	14100	6.35	22900	8.72	31400	ON	OFF	ON	ON	ON	OFF	4.4
3.94	14200	6.39	23000	8.78	31600	OFF	OFF	ON	ON	ON	OFF	4.5
3.97	14300	6.42	23100	8.85	31900	ON	ON	OFF	ON	ON	OFF	4.6
4.00	14400	6.46	23300	8.91	32100	OFF	ON	OFF	ON	ON	OFF	4.7
4.03	14500	6.50	23400	8.98	32300	ON	OFF	OFF	ON	ON	OFF	4.8
4.05	14600	6.54	23500	9.04	32600	OFF	OFF	OFF	ON	ON	OFF	4.9
4.07	14700	6.58	23700	9.11	32800	ON	ON	ON	OFF	ON	OFF	5.0
4.09	14700	6.62	23800	9.18	33000	OFF	ON	ON	OFF	ON	OFF	5.1
4.11	14800	6.67	24000	9.25	33300	ON	OFF	ON	OFF	ON	OFF	5.2
4.12	14800	6.72	24200	9.32	33500	OFF	OFF	ON	OFF	ON	OFF	5.3
4.13	14900	6.77	24400	9.39	33800	ON	ON	OFF	OFF	ON	OFF	5.4
4.14	14900	6.82	24600	9.46	34100	OFF	ON	OFF	OFF	ON	OFF	5.5
4.15	14900	6.88	24800	9.54	34300	ON	OFF	OFF	OFF	ON	OFF	5.6
4.15	15000	6.94	25000	9.62	34600	OFF	OFF	OFF	OFF	ON	OFF	5.7
4.16	15000	7.01	25200	9.70	34900	ON	ON	ON	ON	OFF	OFF	5.8
4.16	15000	7.08	25500	9.79	35300	OFF	ON	ON	ON	OFF	OFF	5.9
4.16	15000	7.15	25700	9.88	35600	ON	OFF	ON	ON	OFF	OFF	6.0

The table comprises the flow setting range for each valve version (low, standard and high flow). Each flow setting is provided by turning the indicated DIP switches to ON or OFF position.

4. Product data sheet

4.2.2 DN80/100L, DN80/100S, DN80/100H flange/flange

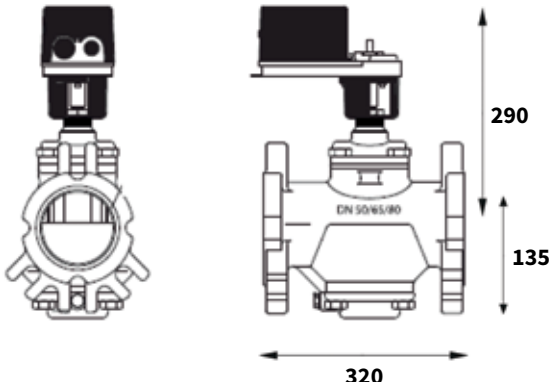
Dimensions	Specifications
	<p>Max. temperature 120°C Min. temperature -20°C Ambient Temperature -10°C to 50°C Max. pressure PN40 (10, 16, 25) Operating pressure 30, 35, 50 – 600 kPa Marking on valve DN, flow direction Connection Universal flange connections for ISO and ANSI flanges Valve housing Ductile iron ASTM A536-65T, class 65-45-18 Diaphragm Hydrogenated acrylonitrile-butadiene-rubber EPDM O-Rings Internal metal components Stainless steel</p>

Valve	Article	Dimensions	Nom. Inch	Kvm m ³ /h	Flow range	
					l/h	l/s
	MN80597.033	DN80/100L	3" / 4"	58.3	12600-33800	3.49-9.38
	MN80597.034	DN80/100S	3" / 4"	58.3	17000-51000	4.73-14.2
	MN80597.035	DN80/100H	3" / 4"	89.0	13300-72700	3.68-20.2

Note!

Delivery comprises the valve, actuator, two 16 mm studs and four 16 mm bolts with nuts for mounting the valve between flanges. Fail safe function is provided on request.

Performance data	
Maximum shut-off pressure	600kPa
Maximum leakage	Below 0.2% of the Kvs value
Flow control accuracy	The greater value of either ±2% of maximum flow or ±5% of controlled flow
Control characteristic	Linear

Note!

The Kvs value must be used only for the leakage rate calculation and not valve sizing. The selection of the valve must be based on the flow table only.

4.2.2.1 Flow and DIP switch setting table

Flow Rate						Maximum Flow Rate DIP Switch Settings						Stem Rotations From Closed
30-600 kPaD		35-600 kPaD		50-600 kPaD		1	2	3	4	5	6	Rotations
DN 80/100L		DN 80/100S		DN 80/100H								
l/s	l/h	l/s	l/h	l/s	l/h							
3.49	12600	4.73	17000	3.68	13300	ON	ON	ON	ON	ON	ON	1.0
3.88	14000	5.29	19000	4.42	15900	OFF	ON	ON	ON	ON	ON	1.1
4.26	15300	5.82	21000	5.13	18500	ON	OFF	ON	ON	ON	ON	1.2
4.61	16600	6.33	22800	5.82	21000	OFF	OFF	ON	ON	ON	ON	1.3
4.94	17800	6.82	24500	6.50	23400	ON	ON	OFF	ON	ON	ON	1.4
5.26	18900	7.28	26200	7.15	25700	OFF	ON	OFF	ON	ON	ON	1.5
5.56	20000	7.72	27800	7.78	28000	ON	OFF	OFF	ON	ON	ON	1.6
5.84	21000	8.14	29300	8.39	30200	OFF	OFF	OFF	ON	ON	ON	1.7
6.11	22000	8.54	30700	8.99	32400	ON	ON	ON	OFF	ON	ON	1.8
6.36	22900	8.91	32100	9.56	34400	OFF	ON	ON	OFF	ON	ON	1.9
6.60	23800	9.27	33400	10.1	36400	ON	OFF	ON	OFF	ON	ON	2.0
6.82	24600	9.61	34600	10.7	38400	OFF	OFF	ON	OFF	ON	ON	2.1
7.03	25300	9.93	35700	11.2	40200	ON	ON	OFF	OFF	ON	ON	2.2
7.23	26000	10.2	36800	11.7	42100	OFF	ON	OFF	OFF	ON	ON	2.3
7.41	26700	10.5	37800	12.2	43800	ON	OFF	OFF	OFF	ON	ON	2.4
7.58	27300	10.8	38800	12.6	45500	OFF	OFF	OFF	OFF	ON	ON	2.5
7.73	27800	11.0	39700	13.1	47100	ON	ON	ON	ON	OFF	ON	2.6
7.88	28400	11.3	40500	13.5	48700	OFF	ON	ON	ON	OFF	ON	2.7
8.01	28800	11.5	41300	13.9	50200	ON	OFF	ON	ON	OFF	ON	2.8
8.14	29300	11.7	42000	14.3	51600	OFF	OFF	ON	ON	OFF	ON	2.9
8.25	29700	11.9	42700	14.7	53000	ON	ON	OFF	ON	OFF	ON	3.0
8.35	30100	12.0	43400	15.1	54300	OFF	ON	OFF	ON	OFF	ON	3.1
8.45	30400	12.2	43900	15.4	55600	ON	OFF	OFF	ON	OFF	ON	3.2
8.53	30700	12.4	44500	15.8	56800	OFF	OFF	OFF	ON	OFF	ON	3.3
8.61	31000	12.5	45000	16.1	58000	ON	ON	ON	OFF	OFF	ON	3.4
8.68	31300	12.6	45500	16.4	59100	OFF	ON	ON	OFF	OFF	ON	3.5
8.74	31500	12.7	45900	16.7	60200	ON	OFF	ON	OFF	OFF	ON	3.6
8.80	31700	12.9	46300	17.0	61200	OFF	OFF	ON	OFF	OFF	ON	3.7
8.85	31900	13.0	46700	17.3	62100	ON	ON	OFF	OFF	OFF	ON	3.8
8.90	32000	13.1	47000	17.5	63000	OFF	ON	OFF	OFF	OFF	ON	3.9
8.93	32200	13.1	47300	17.8	63900	ON	OFF	OFF	OFF	OFF	ON	4.0
8.97	32300	13.2	47600	18.0	64700	OFF	OFF	OFF	OFF	OFF	ON	4.1
9.00	32400	13.3	47800	18.2	65500	ON	ON	ON	ON	ON	OFF	4.2
9.03	32500	13.4	48100	18.4	66200	OFF	ON	ON	ON	ON	OFF	4.3
9.05	32600	13.4	48300	18.6	66900	ON	OFF	ON	ON	ON	OFF	4.4
9.07	32600	13.5	48500	18.8	67600	OFF	OFF	ON	ON	ON	OFF	4.5
9.09	32700	13.5	48700	18.9	68200	ON	ON	OFF	ON	ON	OFF	4.6
9.10	32800	13.6	48800	19.1	68700	OFF	ON	OFF	ON	ON	OFF	4.7
9.12	32800	13.6	49000	19.2	69200	ON	OFF	OFF	ON	ON	OFF	4.8
9.13	32900	13.7	49200	19.4	69700	OFF	OFF	OFF	ON	ON	OFF	4.9
9.15	32900	13.7	49300	19.5	70200	ON	ON	ON	OFF	ON	OFF	5.0
9.16	33000	13.7	49500	19.6	70600	OFF	ON	ON	OFF	ON	OFF	5.1
9.18	33000	13.8	49600	19.7	70900	ON	OFF	ON	OFF	ON	OFF	5.2
9.19	33100	13.8	49800	19.8	71300	OFF	OFF	ON	OFF	ON	OFF	5.3
9.21	33200	13.9	49900	19.9	71600	ON	ON	OFF	OFF	ON	OFF	5.4
9.23	33200	13.9	50100	20.0	71900	OFF	ON	OFF	OFF	ON	OFF	5.5
9.25	33300	14.0	50200	20.0	72100	ON	OFF	OFF	OFF	ON	OFF	5.6
9.28	33400	14.0	50400	20.1	72300	OFF	OFF	OFF	OFF	ON	OFF	5.7
9.31	33500	14.1	50600	20.1	72500	ON	ON	ON	ON	OFF	OFF	5.8
9.34	33600	14.1	50800	20.2	72600	OFF	ON	ON	ON	OFF	OFF	5.9
9.38	33800	14.2	51000	20.2	72700	ON	OFF	ON	ON	OFF	OFF	6.0

The table comprises the flow setting range for each valve version (low, standard and high flow). Each flow setting is provided by turning the indicated DIP switches to ON or OFF position.

4. Product data sheet

4.2.3 DN125/150S, DN125/150H flange/flange

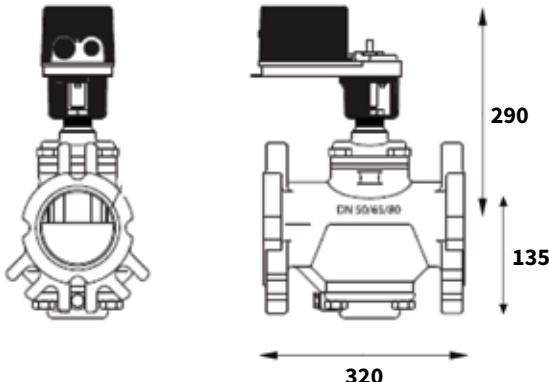
Dimensions	Specifications
	<p>Max. temperature 120°C Min. temperature -20°C Ambient Temperature -10°C to 50°C Max. pressure PN40 (10, 16, 25) Operating pressure 30, 35 – 600 kPa Marking on valve DN, flow direction Connection Universal flange connections for ISO and ANSI flanges Valve housing Ductile iron ASTM A536-65T, class 65-45-18 Diaphragm Hydrogenated acrylonitrile-butadiene-rubber EPDM O-Rings Internal metal components Stainless steel</p>

Valve	Article	Dimensions	Nom. Inch	Kvm m ³ /h	Flow range	
					l/h	l/s
	MN80597.036	DN125/150S	5" / 6"	132.3	23300-83800	6.48-23.3
	MN80597.037	DN125/150H	5" / 6"	132.3	25600-106000	7.10-29.5

Note!

Delivery comprises the valve, actuator, two 16 mm studs and four 16 mm bolts with nuts for mounting the valve between flanges. Fail safe function is provided on request.

Performance data	
Maximum shut-off pressure	600kPa
Maximum leakage	Below 0.2% of the Kvs value
Flow control accuracy	The greater value of either ±2% of maximum flow or ±5% of controlled flow
Control characteristic	Linear

Note!

The Kvs value must be used only for the leakage rate calculation and not valve sizing. The selection of the valve must be based on the flow table only.

4.2.3.1 Flow and DIP switch setting table

Flow Rate				Maximum Flow Rate DIP Switch Settings						Stem Rotations From Closed
30-600 kPaD		35-600 kPaD		1	2	3	4	5	6	Rotations
DN 125/150S		DN 125/150H								
l/s	l/h	l/s	l/h							
6.48	23300	7.10	25600	ON	ON	ON	ON	ON	ON	1.0
7.24	26100	8.06	29000	OFF	ON	ON	ON	ON	ON	1.1
7.98	28700	8.98	32300	ON	OFF	ON	ON	ON	ON	1.2
8.69	31300	9.87	35500	OFF	OFF	ON	ON	ON	ON	1.3
9.39	33800	10.7	38600	ON	ON	OFF	ON	ON	ON	1.4
10.1	36200	11.6	41600	OFF	ON	OFF	ON	ON	ON	1.5
10.7	38600	12.4	44500	ON	OFF	OFF	ON	ON	ON	1.6
11.4	40900	13.1	47300	OFF	OFF	OFF	ON	ON	ON	1.7
12.0	43100	13.9	50000	ON	ON	ON	OFF	ON	ON	1.8
12.6	45200	14.6	52600	OFF	ON	ON	OFF	ON	ON	1.9
13.1	47300	15.3	55100	ON	OFF	ON	OFF	ON	ON	2.0
13.7	49300	16.0	57500	OFF	OFF	ON	OFF	ON	ON	2.1
14.2	51200	16.6	59800	ON	ON	OFF	OFF	ON	ON	2.2
14.7	53100	17.2	62100	OFF	ON	OFF	OFF	ON	ON	2.3
15.3	54900	17.8	64200	ON	OFF	OFF	OFF	ON	ON	2.4
15.7	56600	18.4	66300	OFF	OFF	OFF	OFF	ON	ON	2.5
16.2	58300	19.0	68300	ON	ON	ON	ON	OFF	ON	2.6
16.6	59900	19.5	70200	OFF	ON	ON	ON	OFF	ON	2.7
17.1	61500	20.0	72100	ON	OFF	ON	ON	OFF	ON	2.8
17.5	63000	20.5	73800	OFF	OFF	ON	ON	OFF	ON	2.9
17.9	64400	21.0	75500	ON	ON	OFF	ON	OFF	ON	3.0
18.3	65800	21.4	77200	OFF	ON	OFF	ON	OFF	ON	3.1
18.6	67100	21.9	78700	ON	OFF	OFF	ON	OFF	ON	3.2
19.0	68300	22.3	80200	OFF	OFF	OFF	ON	OFF	ON	3.3
19.3	69500	22.7	81700	ON	ON	ON	OFF	OFF	ON	3.4
19.6	70700	23.1	83100	OFF	ON	ON	OFF	OFF	ON	3.5
19.9	71700	23.4	84400	ON	OFF	ON	OFF	OFF	ON	3.6
20.2	72800	23.8	85700	OFF	OFF	ON	OFF	OFF	ON	3.7
20.5	73800	24.1	86900	ON	ON	OFF	OFF	OFF	ON	3.8
20.7	74700	24.5	88100	OFF	ON	OFF	OFF	OFF	ON	3.9
21.0	75600	24.8	89200	ON	OFF	OFF	OFF	OFF	ON	4.0
21.2	76400	25.1	90300	OFF	OFF	OFF	OFF	OFF	ON	4.1
21.4	77200	25.4	91400	ON	ON	ON	ON	ON	OFF	4.2
21.6	77900	25.7	92400	OFF	ON	ON	ON	ON	OFF	4.3
21.8	78600	25.9	93400	ON	OFF	ON	ON	ON	OFF	4.4
22.0	79200	26.2	94300	OFF	OFF	ON	ON	ON	OFF	4.5
22.2	79800	26.5	95200	ON	ON	OFF	ON	ON	OFF	4.6
22.3	80300	26.7	96100	OFF	ON	OFF	ON	ON	OFF	4.7
22.5	80800	26.9	97000	ON	OFF	OFF	ON	ON	OFF	4.8
22.6	81300	27.2	97800	OFF	OFF	OFF	ON	ON	OFF	4.9
22.7	81700	27.4	98600	ON	ON	ON	OFF	ON	OFF	5.0
22.8	82100	27.6	99400	OFF	ON	ON	OFF	ON	OFF	5.1
22.9	82400	27.8	100000	ON	OFF	ON	OFF	ON	OFF	5.2
23.0	82700	28.1	101000	OFF	OFF	ON	OFF	ON	OFF	5.3
23.0	83000	28.3	102000	ON	ON	OFF	OFF	ON	OFF	5.4
23.1	83200	28.5	102000	OFF	ON	OFF	OFF	ON	OFF	5.5
23.2	83400	28.7	103000	ON	OFF	OFF	OFF	ON	OFF	5.6
23.2	83500	28.9	104000	OFF	OFF	OFF	OFF	ON	OFF	5.7
23.2	83600	29.1	105000	ON	ON	ON	ON	OFF	OFF	5.8
23.3	83700	29.3	105000	OFF	ON	ON	ON	OFF	OFF	5.9
23.3	83800	29.5	106000	ON	OFF	ON	ON	OFF	OFF	6.0

The table comprises the flow setting range for each valve version (standard and high flow). Each flow setting is provided by turning the indicated DIP switches to ON or OFF position.

4. Product data sheet

4.2.4 DN200/250 flange/flange

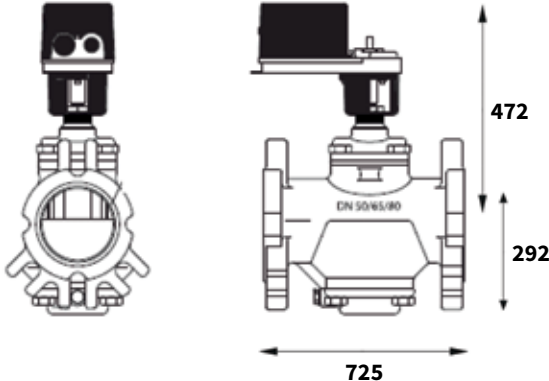
Dimensions	Specifications
	<p>Max. temperature 120°C Min. temperature -20°C Ambient Temperature -10°C to 50°C Max. pressure PN40 (10, 16, 25) Operating pressure 35-600kPa Marking on valve DN, flow direction Connection Universal flange connections for ISO and ANSI flanges Valve housing Ductile iron ASTM A536-65T, class 65-45-18 Diaphragm Hydrogenated acrylonitrile-butadiene-rubber EPDM O-Rings Internal metal components Stainless steel</p>

Valve	Article	Dimensions	Nom. Inch	Kvm m ³ /h	Flow range	
					l/h	l/s
	MN80597.038	DN200/250	8" / 10"	33.1 - 277	33100-277000	3.49-9.38

Note!

Delivery comprises the valve, actuator, two 16 mm studs and four 16 mm bolts with nuts for mounting the valve between flanges. Fail safe function is provided on request.

Performance data	
Maximum shut-off pressure	600kPa
Maximum leakage	Below 0.2% of the Kvs value
Flow control accuracy	The greater value of either ±2% of maximum flow or ±5% of controlled flow
Control characteristic	Linear

Note!

The Kvs value must be used only for the leakage rate calculation and not valve sizing. The selection of the valve must be based on the flow table only.

4.2.4.1 Flow and DIP switch setting table

Flow Rate				Maximum Flow Rate DIP Switch Settings						Stem Rotations From Closed
35-600 kPaD										
DN 200/250										
l/s	l/h	l/s	l/h	1	2	3	4	5	6	Rotations
9.21	33100	57.5	207000	ON	ON	ON	ON	ON	ON	1.0
9.59	34900	58.3	210000	OFF	ON	ON	ON	ON	ON	1.1
10.2	36800	59.1	213000	ON	OFF	ON	ON	ON	ON	1.2
10.8	38900	59.8	215000	OFF	OFF	ON	ON	ON	ON	1.3
11.5	41200	60.6	218000	ON	ON	OFF	ON	ON	ON	1.4
12.1	43700	61.3	221000	OFF	ON	OFF	ON	ON	ON	1.5
12.9	46300	62.0	223000	ON	OFF	OFF	ON	ON	ON	1.6
13.6	49100	62.7	226000	OFF	OFF	OFF	ON	ON	ON	1.7
14.5	52000	63.4	228000	ON	ON	ON	OFF	ON	ON	1.8
15.3	55100	64.0	230000	OFF	ON	ON	OFF	ON	ON	1.9
16.2	58200	64.6	233000	ON	OFF	ON	OFF	ON	ON	2.0
17.1	61500	65.2	235000	OFF	OFF	ON	OFF	ON	ON	2.1
18.0	64900	65.8	237000	ON	ON	OFF	OFF	ON	ON	2.2
19.0	68400	66.4	239000	OFF	ON	OFF	OFF	ON	ON	2.3
20.0	71900	66.9	241000	ON	OFF	OFF	OFF	ON	ON	2.4
21.0	75600	67.4	243000	OFF	OFF	OFF	OFF	ON	ON	2.5
22.0	79300	68.0	245000	ON	ON	ON	ON	OFF	ON	2.6
23.1	83100	68.4	246000	OFF	ON	ON	ON	OFF	ON	2.7
24.1	86900	68.9	248000	ON	OFF	ON	ON	OFF	ON	2.8
25.2	90800	69.4	250000	OFF	OFF	ON	ON	OFF	ON	2.9
26.3	94700	69.8	251000	ON	ON	OFF	ON	OFF	ON	3.0
27.4	98700	70.2	253000	OFF	ON	OFF	ON	OFF	ON	3.1
28.5	103000	70.6	254000	ON	OFF	OFF	ON	OFF	ON	3.2
29.6	107000	71.0	256000	OFF	OFF	OFF	ON	OFF	ON	3.3
30.8	111000	71.4	257000	ON	ON	ON	OFF	OFF	ON	3.4
31.9	115000	71.8	258000	OFF	ON	ON	OFF	OFF	ON	3.5
33.0	119000	72.1	260000	ON	OFF	ON	OFF	OFF	ON	3.6
34.2	123000	72.5	261000	OFF	OFF	ON	OFF	OFF	ON	3.7
35.3	127000	72.8	262000	ON	ON	OFF	OFF	OFF	ON	3.8
36.4	131000	73.2	263000	OFF	ON	OFF	OFF	OFF	ON	3.9
37.5	135000	73.5	265000	ON	OFF	OFF	OFF	OFF	ON	4.0
38.6	139000	73.8	266000	OFF	OFF	OFF	OFF	OFF	ON	4.1
39.8	143000	74.2	267000	ON	ON	ON	ON	ON	OFF	4.2
40.9	147000	74.5	268000	OFF	ON	ON	ON	ON	OFF	4.3
41.9	151000	74.8	269000	ON	OFF	ON	ON	ON	OFF	4.4
43.0	155000	75.1	270000	OFF	OFF	ON	ON	ON	OFF	4.5
44.1	159000	75.5	272000	ON	ON	OFF	ON	ON	OFF	4.6
45.2	163000	75.8	273000	OFF	ON	OFF	ON	ON	OFF	4.7
46.2	166000	76.1	274000	ON	OFF	OFF	ON	ON	OFF	4.8
47.2	170000	76.5	275000	OFF	OFF	OFF	ON	ON	OFF	4.9
48.3	174000	76.8	277000	ON	ON	ON	OFF	ON	OFF	5.0
49.3	177000			OFF	ON	ON	OFF	ON	OFF	5.1
50.2	181000			ON	OFF	ON	OFF	ON	OFF	5.2
51.2	184000			OFF	OFF	ON	OFF	ON	OFF	5.3
52.2	188000			ON	ON	OFF	OFF	ON	OFF	5.4
53.1	191000			OFF	ON	OFF	OFF	ON	OFF	5.5
54.0	194000			ON	OFF	OFF	OFF	ON	OFF	5.6
54.9	198000			OFF	OFF	OFF	OFF	ON	OFF	5.7
55.8	201000			ON	ON	ON	ON	OFF	OFF	5.8
56.6	204000			OFF	ON	ON	ON	OFF	OFF	5.9
57.5	207000			ON	OFF	ON	ON	OFF	OFF	6.0

The table comprises the flow setting range for each valve version (standard and high flow). Each flow setting is provided by turning the indicated DIP switches to ON or OFF position.

4. Product data sheet

4.3 Flanges for NexusValve Vivax Plus

NexusValve Vivax Plus is designed so that one valve body can be mounted between the flanges of different diameters pipes:

NexusValve	Mounting possible between flanges of pipes
MN80597.030 MN80597.031 MN80597.032	DN50, DN65 and DN80
MN80597.033 MN80597.034 MN80597.035	DN80 and DN100
MN80957.036 MN80957.037	DN125 and DN150
MN80597.038	DN200 and DN250

Every valve is provided with two 16mm studs and four 16mm bolts with nuts for mounting the valve between flanges. The flanges which can be used with NexusValve Vivax Plus are specified in the table:

Valve size DN	Flange size (inch)	ASME B16.5 weld neck flanges		ASME B16.5 slip on flanges		Flange size (mm)	EN1092-1*				EN1092-1**				
		Class 150	Class 300	Class 150	Class 300		PN10	PN16	PN25	PN40	PN10	PN16	PN25	PN40	
65/80	2	-	✓	-	✓	50	✓	✓	✓	✓	✓	✓	✓	✓	✓
	2 ½	✓	✓	✓	✓	65	✓	✓	✓	✓	✓	✓	✓	✓	✓
	3	✓	✓	-	-	80	✓	✓	✓	✓	-	-	-	-	-
80/100	3	✓	✓	✓	✓	80	✓	✓	✓	✓	✓	✓	✓	✓	✓
	4	✓	✓	-	-	100	✓	✓	✓	✓	-	-	-	-	-
100/125	5	✓	✓	✓	✓	125	✓	✓	✓	✓	✓	✓	✓	✓	✓
	6	✓	-	-	-	150	✓	✓	✓	✓	-	-	-	-	-
200/250	8	-	✓	-	✓	200	-	-	✓	✓	-	-	✓	✓	✓
	10	✓	-	✓	-	250	-	✓	✓	✓	-	✓	✓	✓	✓

*Type 02 and 35/36/37 (loose plate ange with welding neck / pressed collar with long neck / pressed collar) or Type 04 and 34 (loose plate ange with weld-neck collar) or Type 11 with ange facing A/B (weld-neck ange with at face or raised face).

** Type 12 with ange facing A/B (hubbed slip-on ange with at face or raised face)

5. Sizing example

NexusValve Vivax Plus valves are in the following example installed in a system of fan coil units. The valves will provide the required flow to the terminal units to control the indoor temperature.

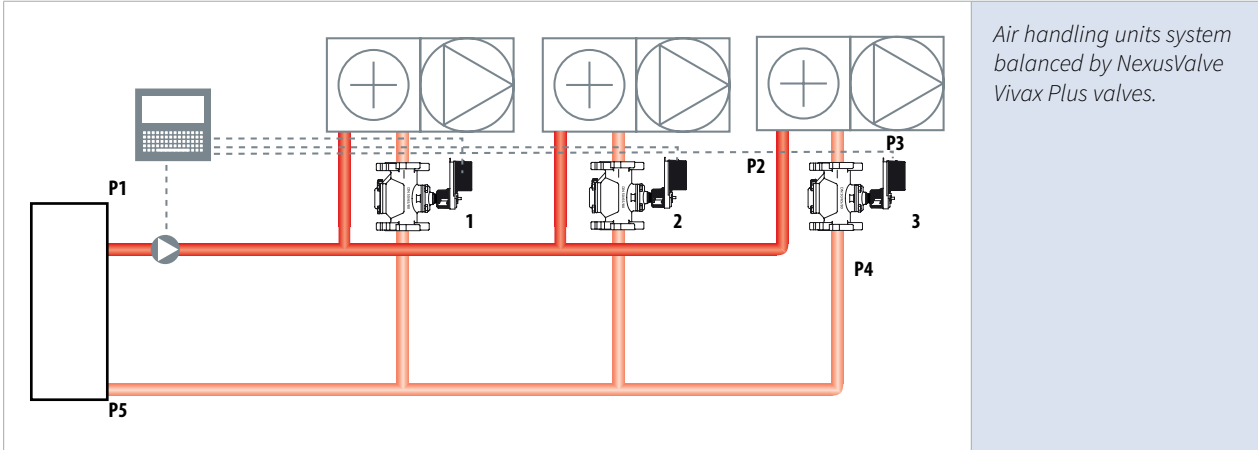

The air handling unit flows specified for the sizing conditions are as follows:

NexusValve Vivax Plus No. 1: required flow 14 500l/h

NexusValve Vivax Plus No. 2: required flow 22 000l/h

NexusValve Vivax Plus No. 3: required flow 71 000l/h

For No. 1 NexusValve Vivax Plus valve the required flow is within a NexusValve Vivax Plus DN65/80L valve flow range.

To find the DN65/80L valve setting, check the flow and DIP switch setting table.

Flow Rate						Maximum Flow Rate DIP Switch Settings						Stem Rotations From Closed
30-600 kPaD		30-600 kPaD		35-600 kPaD								
DN 65/80L		DN 65/80S		DN 65/80H								
l/s	l/h	l/s	l/h	l/s	l/h	1	2	3	4	5	6	Rotations
3.62	13000	6.06	21800	8.20	29500	OFF	OFF	ON	OFF	OFF	ON	3.7
3.67	13200	6.10	22000	8.28	29800	ON	ON	OFF	OFF	OFF	ON	3.8
3.72	13400	6.15	22100	8.36	30100	OFF	ON	OFF	OFF	OFF	ON	3.9
3.76	13500	6.19	22300	8.44	30400	ON	OFF	OFF	OFF	OFF	ON	4.0
3.80	13700	6.23	22400	8.51	30600	OFF	OFF	OFF	OFF	OFF	ON	4.1
3.84	13800	6.27	22600	8.58	30900	ON	ON	ON	ON	ON	OFF	4.2
3.88	14000	6.31	22700	8.65	31100	OFF	ON	ON	ON	ON	OFF	4.3
3.91	14100	6.35	22900	8.72	31400	ON	OFF	ON	ON	ON	OFF	4.4
3.94	14200	6.39	23000	8.78	31600	OFF	OFF	ON	ON	ON	OFF	4.5
3.97	14300	6.42	23100	8.85	31900	ON	ON	OFF	ON	ON	OFF	4.6
4.00	14400	6.46	23300	8.91	32100	OFF	ON	OFF	ON	ON	OFF	4.7
4.03	14500	6.50	23400	8.98	32300	ON	OFF	OFF	ON	ON	OFF	4.8
4.05	14600	6.54	23500	9.04	32600	OFF	OFF	OFF	ON	ON	OFF	4.9
4.07	14700	6.58	23700	9.11	32800	ON	ON	ON	OFF	ON	OFF	5.0
4.09	14700	6.62	23800	9.18	33000	OFF	ON	ON	OFF	ON	OFF	5.1
4.11	14800	6.67	24000	9.25	33300	ON	OFF	ON	OFF	ON	OFF	5.2
4.12	14800	6.72	24200	9.32	33500	OFF	OFF	ON	OFF	ON	OFF	5.3
4.13	14900	6.77	24400	9.39	33800	ON	ON	OFF	OFF	ON	OFF	5.4

Flow and DIP switch setting table

For the flow of 14500l/h, specified in the project the installer must provide the following DIP switch settings:

DIP switches No. 1, 4 and 5: ON / DIP switches No. 2, 3 and 6: OFF

The flow to the air handling unit No. 2 is within the NexusValve Vivax Plus DN80/100L range.

For the flow of 22000l/h, specified in the project the installer must provide the following DIP switch settings:

DIP switches No. 1, 2, 3, 5 and 6: ON / DIP switch No. 4: OFF

The flow to the air handling unit no 3 is within NexusValve Vivax Plus DN125/150S range.

For the flow of 71000l/h, specified in the project the installer must provide the following DIP switch settings:

DIP switches No. 2, 3 and 6: ON / DIP switches No. 1, 4 and 5: OFF

All the selected valves control flows within the differential pressure range of 35 – 400kPa. Knowing that air handling unit No. 3 is in the index circuit, the pump head can be calculated.

The pump head must be equal to the pressure loss generated in the heat exchanger, in pipes and in equipment like service valves, strainers as well as in the air handling unit. In addition, 35.0 kPa ($\Delta P_B = P_3 - P_4$) required for the NexusValve Vivax Plus is to be added.

If the pressure loss calculated along the circuit P1,P2,P3,P4,P5,P1 (excluding NexusValve Vivax Plus) equals $\Delta P_c = 32.0$ kPa, the pump head ΔP_h must be at least:

$$\Delta P_h = \Delta P_c + \Delta P_B = 32.0 + 35.0 \text{ kPa} = 67.0 \text{ kPa.}$$

If a variable speed pump is used, it is to be operated in a constant differential pressure mode (67.0 kPa) to provide the NexusValve Vivax Plus valves with at least 35 kPa differential pressure at all times.

Ordering:

NexusValve Vivax Plus No. 1 product no: MN80597.030

NexusValve Vivax Plus No. 2 product no: MN80597.033

NexusValve Vivax Plus No. 3 product no: MN80957.036

5.1 General specifications NexusValve Vivax Plus DN65-250

1. Pressure independent flow control valve NexusValve Vivax Plus

- 1.1. The contractor must install the pressure independent control valves where indicated in drawings.

2. Function

- 2.1. The valve shall be an electronic, dynamic, modulating, two-way control device.
- 2.2. The dynamic control valve shall control flow independent of system pressure fluctuations.
- 2.3. The maximum flow setting shall be adjustable to 51 different settings within the range of the valve size.

3. Valve Body

- 3.1. The housing shall be made of ductile iron ASTM A536-65T, Class 60-45-18 rated at no less than 4000 kPa static pressure and +120°C.
- 3.2. The valve housing shall be for installation between flanges.
- 3.3. The P/T plugs for verifying differential pressure shall be provided for all valve sizes.
- 3.4. The identification tags shall be available for all valves; tags shall be indelibly marked with part number, production date and pressure differential range. Tags shall be of aluminium and in size 50mm x 25mm.

4. Flow regulation unit

- 4.1. The flow regulation unit shall consist of stainless steel and hydrogenated acrylonitrile-butadiene-rubber and shall be capable of controlling flow with accuracy of $\pm 2\%$ of maximum flow or $\pm 5\%$ of controlled flow.
- 4.2. The flow regulation unit shall be accessible for replacement or maintenance.

5. Actuator

- 5.1. The valve actuator housing shall be rated to IP42.
- 5.2. The actuator shall be driven by a 24V AC / 30V DC motor and shall accept 2-10V DC, 4-20 mA, 3-point floating or pulse width modulation electric signal and shall include resistor to facilitate any of these signals.
- 5.3. The actuator shall be capable of providing 2-10V DC or 4-20 mA feedback signal to the control system.
- 5.4. An optional fail safe system to power the valve to either open or closed position from any position in case of power failure shall be available.
- 5.5. The external LED read-out of current valve position and maximum valve position setting shall be standard.

Notes

Notes

The Netherlands (HQ)

Aalberts hydronic flow control
+31 36 52 62 300
info@flamcogroup.com
info@comap.nl

China

Flamco Heating Accessories
(Changshu) Ltd, Co.
+86 512 528 417 31
yecho@flamco.com.cn

Denmark

Flamco Denmark
+45 44 94 02 07
info@flamco.dk

France

Flamco s.a.r.l.
+33 1 342 191 91
info@flamco.fr

Germany

Flamco GmbH
+49 2104 80006 20
info@flamco.de

Italy

Distributore: Commerciale Delta
+39 (0)2 242 8303
vendite@commercialedelta.it

Slovakia

Flamco SK s.r.o.
+421 475 634 043
info@meibes.sk

Sweden

Flamco Sverige
+46 50 042 89 95
vvs@flamco.se

United Arab Emirates

Flamco Middle East
+971 4 8819540
info@flamco-gulf.com

Belgium

Flamco BeLux
+32 50 31 67 16
info@flamco.be

Czech Republic

Flamco CZ s.r.o.
+420 284 00 10 81
info@meibes.cz

Estonia

Flamco Baltic
+372 568 838 38
info@flamco.ee

France

Comap s.a.r.l.
+33 4 78 78 16 00
marketing@comap.eu

Hungary

Flamco Kft
+36 23 880981
info@flamco.hu

Poland

Flamco Meibes Sp. z o.o.
+48 65 529 49 89
info@flamco.pl

Russian Federation

ООО „Майбес РУС“
+7 495 727 20 26
moscow@meibes.ru

Switzerland

Flamco AG
+41 41 854 30 50
info@flamco.ch

Export

Comap International
+33 4 78 78 16 00
export.contacts@comap.eu

Comap BeLux
+32 2 371 01 67
info@comap.be

Comap Praha s.r.o.
+420 284 860 404
marketing.praha@comap.eu

Finland

Flamco Finland
+358 10 320 99 90
info@flamco.fi

Germany

Meibes System-Technik GmbH
+49 342 927 130
info@meibes.com

Comap Hungária Kft.
+36 23 503 871
comap.hungary@comap.eu

Comap Polska Sp. z o.o.
+48 22 679 00 25
comap@comap.pl

Comap Россия (офис)
+7 499 703 33 56
info.rus@comap.eu

United Kingdom

Flamco Limited
+44 17 447 447 44
info@flamco.co.uk

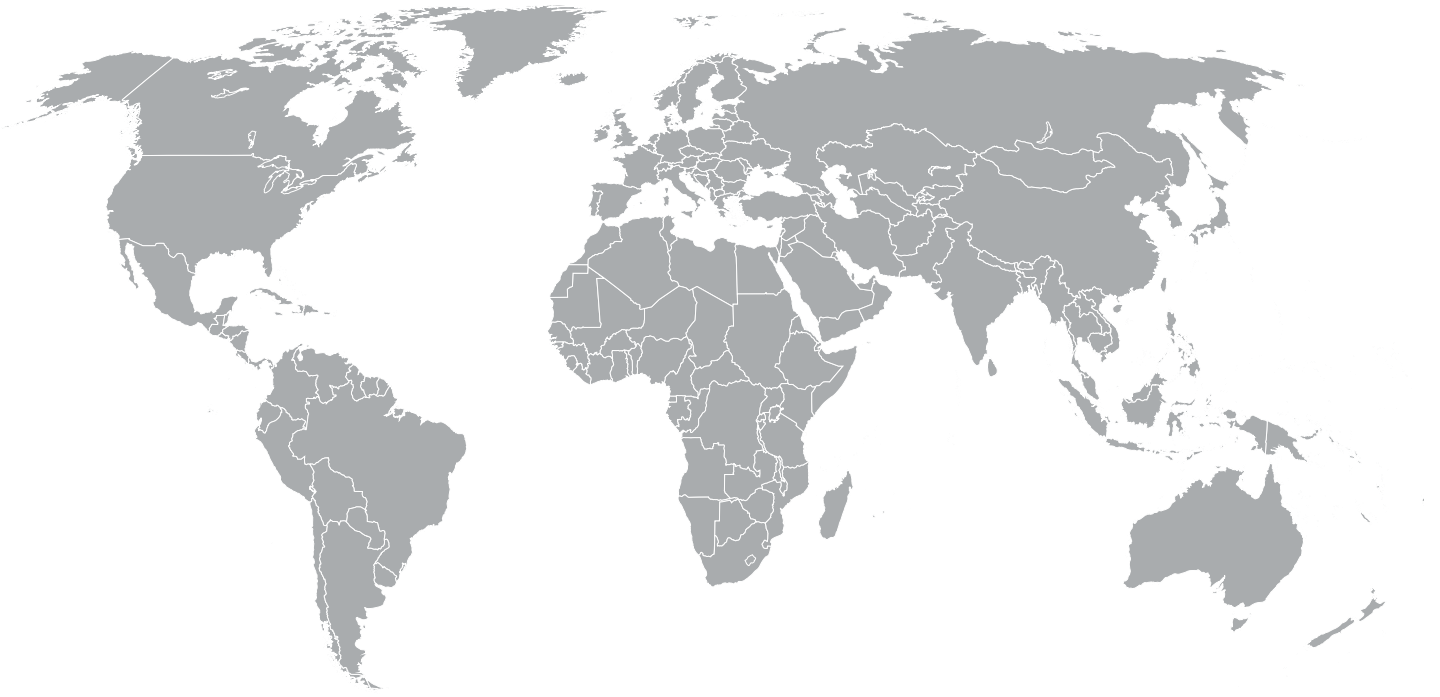

Subject to technical modifications

24004.047 Valid since 2021-06