

COMAP

GHID DE SELECȚIE

MultiSkin

Soluții noi multistrat
Push-Fit



Conexiuni sintetice Push-Fit

Cot egal Push-Fit 90°

9090P

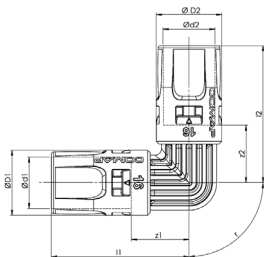

Dimensiuni	Cod produs	d1 - d2	z1- z2	l1 - l2	(buc)
16x2	9090P16	16	18	43	2
20x2	9090P20	20	20	46	2
26x3	9090P26	26	29	50	2

Cot Push-Fit cu Filet Exterior

9092GP

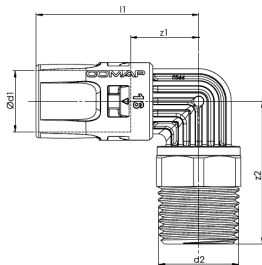

Dimensiuni	Cod produs	d1	d2	z1	z2	l1	l2	(buc).
16x2 - 1/2	9090GP1612	16	G 1/2	19	32	43	45	2
20x2 - 1/2	9090GP2012	20	G 1/2	20	33	46	46	2
20x2 - 3/4	9090GP2034	20	G 3/4	20	37	46	52	2
26x3 - 3/4	9090GP2634	26	G 3/4	22	39	49	54	2

Cot Push-Fit cu Filet Interior

9090GP

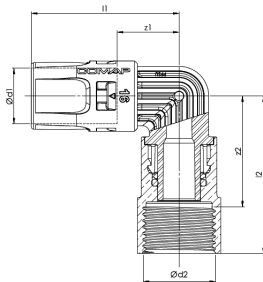

Dimensiuni	Cod produs	d1	d2	z1	z2	l1	l2	(buc)
16x2 - 1/2	9090GP1612	16	G 1/2	19	32	43	45	2
20x2 - 1/2	9090GP2012	20	G 1/2	20	33	46	46	2
20x2 - 3/4	9090GP2034	20	G 3/4	20	37	46	52	2
26x3 - 3/4	9090GP2634	26	G 3/4	22	39	49	54	2

Capac Push-Fit

9300P

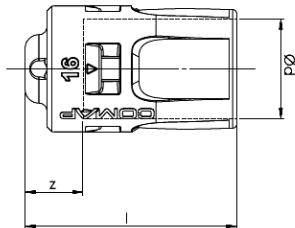

Dimensiuni	Cod produs	d1	z1	l1	(buc)
16x2	9300P16	16	9	34	2
20x2	9300P20	20	9	35	2
26x3	9300P26	26	10	37	2

Fiting de trecere Multistrat - Cupru

9871P

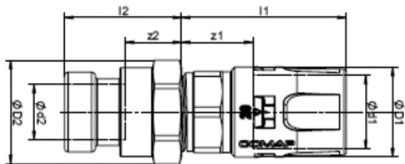
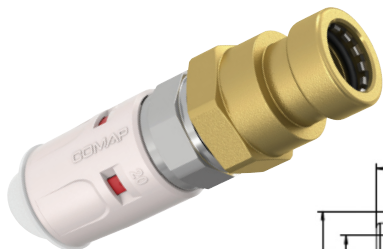

Dimensiuni	Cod produs	Do1	Do2	DN1	DN2	L1	L2	Z1	Z2
Co16-M15	CP9871P1615	16	15	12	13	44	32	19	16
Co20-M15	CP9871P2015	20	15	16	13	46	32	19	16
Co20-M18	CP9871P2018	20	18	16	16	50	37	24	18

Mufă Push-Fit

9270P

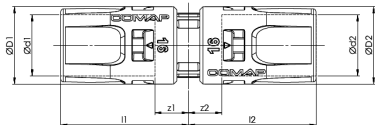

Dimensiuni	Cod produs	d1 d2	z1 z2	l1 l2	(buc)
16x2	9270P16	16	9	34	2
20x2	9270P20	20	9	35	2
26x3	9270P26	26	10	37	2

Mufă redusă Push-Fit

9240P

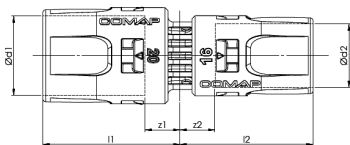

Dimensiuni	Cod produs	d1	d2	z1	z2	l1	l2	(buc)
16x2 - 14x2	9240P1614	16	14	9	9	34	34	2
20x2 - 16x2	9240P2016	20	16	9	9	35	34	2
26x3 - 16x2	9240P2616	26	16	10	9	37	34	2
26x3 - 20x2	9240P2620	26	20	10	9	37	35	2

Adaptor Push-Fit cu Filet Interior

9270GP

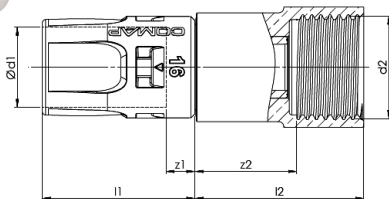

Dimensiuni	Cod produs	d1	d2	z1	z2	l1	l2	(buc)
16x2 - 1/2	9270GP1612	16	G 1/2"	6	20	31	34	2
20x2 - 1/2	9270GP2012	20	G 1/2"	6	20	32	34	2
20x2 - 3/4	9270GP2034	20	G 3/4"	6	24	32	38	2
26x3 - 3/4	9270GP2634	26	G 3/4"	6	24	33	39	2
26x3 - 1"	9270GP261	26	G 1"	6	24	33	42	2

Adaptor Push-Fit cu Filet Exterior

9243GP

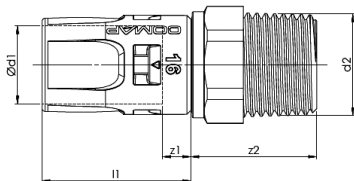

Dimensiuni	Cod produs	d1	d2	z1	z2	l1	(buc)
16x2 - 3/8	9243GP1638	16	R 3/8"	6	27	31	2
16x2 - 1/2	9243GP1612	16	R 1/2"	6	26	31	2
20x2 - 1/2	9243GP2012	20	R 1/2"	6	26	32	2
20x2 - 3/4	9243GP2034	20	R 3/4"	6	31	32	2
26x3 - 3/4	9243GP2634	26	R 3/4"	6	32	33	2
26x3 - 1"	9243GP261	26	R 1"	6	31	33	2

Suport cu două coturi de perete, pentru baterii, Push-Fit

9507P



Dimensiuni	Cod produs	d1	d2	d3 d4	z1 z2	l1 l2	l3	l4	H2 H3	(buc)
14x2 - 1/2 - H1 150	CP9507P161412	14	16	34	3	59	23	40	20	2
16x2 - 1/2 - H1 150	CP9507P1612	16	16	34	3	58	23	40	20	2

Teu Push-Fit cu Filet Interior

9130GP

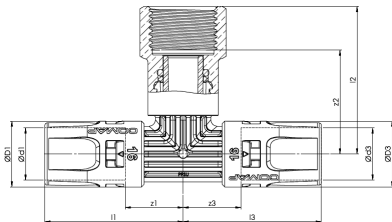
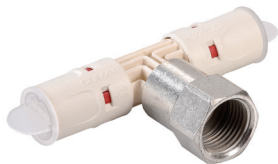

Dimensiuni	Cod produs	d1 d3	d2	z1 z3	z2	l1 l3	l2	(buc)
16x2 - 1/2 - 16x2	9130GP161216	16	G 1/2	18	32	43	43	2
20x2 - 1/2 - 20x2	9130GP201220	20	G 1/2	20	33	46	46	2
26x3 - 3/4 - 26x3	9130GP263426	26	G 3/4	21	40	49	54	2

Teu Redus Push-Fit

9130RP

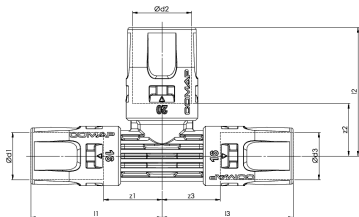

Dimensiuni	Cod produs	d1	d2	d3	z1 z3	z2	l1 l3	l2	(buc)
16x2 - 14x2 - 16x2	9130RP161416	16	14	16	17	18	42	42	2
16x2 - 20x2 - 16x2	9130RP162016	16	20	16	20	27	45	44	2
20x2 - 16x2 - 16x2	9130RP201616	20	16	16	18	20	44	45	2
20x2 - 16x2 - 20x2	9130RP201620	20	16	20	18	20	44	45	2
20x2 - 20x2 - 16x2	9130RP202016	20	20	16	20	20	46	46	2
26x3 - 16x2 - 26x3	9130RP261626	26	16	26	18	23	45	48	2
26x3 - 20x2 - 20x2	9130RP262020	26	20	20	20	23	47	48	2
26x3 - 20x2 - 26x3	9130RP262026	26	20	26	20	23	47	48	2

Teu Egal Push-Fit

9130P

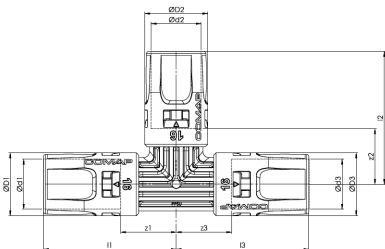

Dimensiuni	Cod produs	d1, d2, d3	z1, z2, z3	l1, l2, l3	(buc)
16x2	9130P16	16	18	43	2
20x2	9130P20	20	20	46	2
26x3	9130P26	26	23	50	2

Cot perete cu talpă cu Filet Interior Push-Fit

9473GP

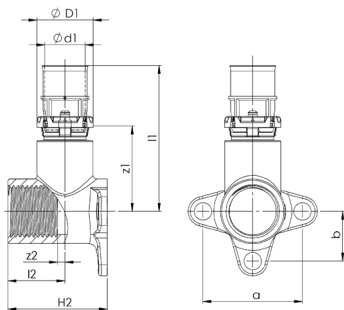

Dimensiuni	Cod produs	d1	d2	z1	z2	l1	l2	a	b	(buc)
14x2 - 1/2 - H2 40	9473GP1412	14	G 1/2"	34	3	59	23	40	20	2
16x2 x 1/2 - H2 40	9473GP1612	16	G 1/2"	34	3	58	23	40	20	2
20x2 - 1/2 - H2 40	9473GP2012	20	G 1/2"	34	3	59	23	40	20	2
20x2 - 3/4 - H2 40	9473GP2034	20	G 3/4"	37	8	61	17	40	20	2

Olandez Push-Fit cu Filet Interior

9359GP

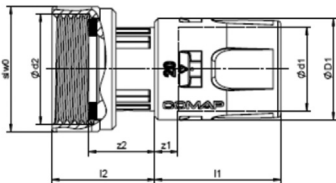

Dimensiuni	Cod produs	Do1	DN1	DN2	Z1	Z2	L1	L2	SW1
16x1/2"	9359GP1612	16	12	G 1/2" F	6	15	31	23	24
20x3/4"	9359GP2034	16	G 1/2"	34	3	58	23	40	20



MultiSkin

soluții noi multistrat tip Push-Fit

PARTENER DE AFACERI

PENTRU AMBELE PĂRȚI

Expert în domeniul instalațiilor, COMAP proiectează și fabrică sisteme de conexiune și țevi multistrat de mai mult de 20 de ani.

Sistemul COMAP MultiSkin este dezvoltat și îmbunătățit în mod continuu cu detalii practice și eficiente care ușurează munca la șantier în timp ce asigură securitatea completă a instalației.

Rețelele multistrat sunt aplicabile la toate sistemele sanitare și de încălzire, totodată oferă o serie de beneficii. Sunt concepute atât pentru construcții noi cât și pentru renovări. Țevile pot fi montate aparent sau în perete sau șapă

Oferta de produse

Cea mai recentă dezvoltare a acestei game este soluția Push-Fit. Prin rapiditatea de lucru cu fittingurile Push-Fit instalatorii beneficiază atât de simplitatea executării instalației cât și de un rezultat de calitate.



Fitinguri prin sertizare metalice

Performanță garantată
De la \varnothing 14 la 75 mm

Fitinguri sintetice Push-Fit

Rapiditate și siguranță

De la \emptyset 14 la 26 mm

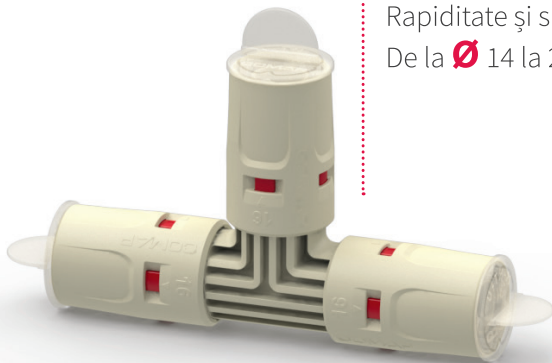

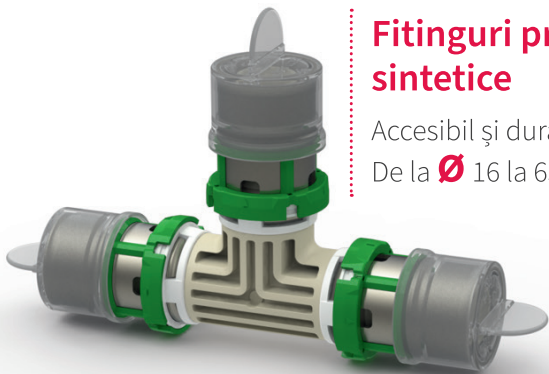

Fitinguri prin sertizare sintetice

Accesibil și durabil

De la \varnothing 16 la 63 mm

Țeavă multistrat

Calitate la toate lucrările

De la \varnothing 14 la 75 mm



Performanță

Noul design reduce scăderile de presiune.

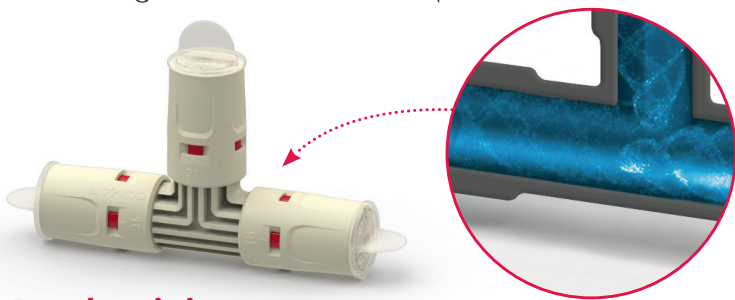

Productivitate

Cu 20% mai rapid decât tehnologia prin sertizare.

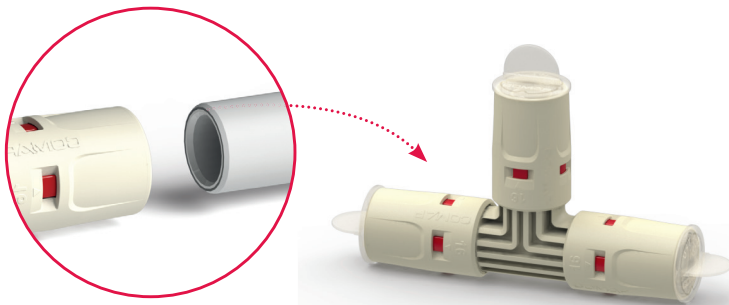

Siguranță

Fără sertizări omise. Indicatorul Visu Control® garantează conexiunea corectă.

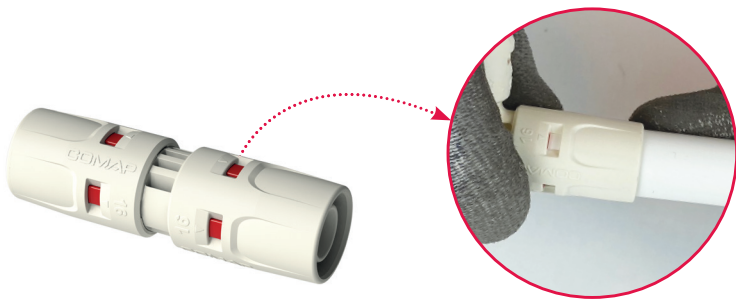

Durabilitate

Corp fitting robust datorită formei cu caneluri.

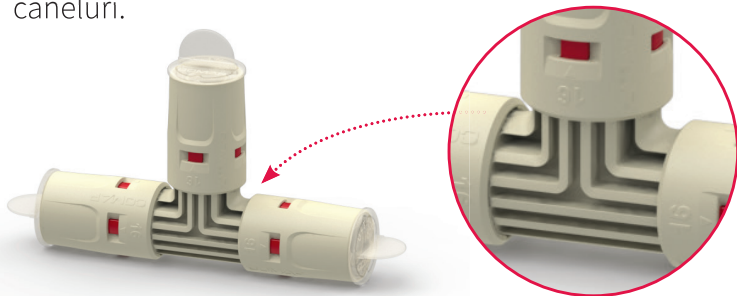

Protecție

Fitingurile sunt echipate cu dopuri de protecție.



Țevi multistrat

Țeavă MultiSkin 4 fără izolație

1. Bare de 5 metri

B111010004	14 x 2 - 5m
B111001004	16 x 2 - 5m
B111003004	20 x 2 - 5m
B111004004	26 x 3 - 5m

Țeavă MultiSkin 2 fără izolație

1. Bare de 5 metri

B211001001	16 x 2 - 5m
B211002001	20 x 2 - 5m
B211004004	26 x 2 - 5m

1.



Țeavă MultiSkin 4 fără izolație

2. Colac

B112001002	14 x 2 - 100m
B112002002	16 x 2 - 100m
B112002003	16 x 2 - 200m
B112003001	18 x 2 - 100m
B112004001	20 x 2 - 100m
B112005001	26 x 3 - 50m
B112006001	32 x 3 - 50m

Țeavă MultiSkin 2 fără izolație

2. Colac

B212001001	14x2 - 100m
B212002001	16x2 - 100m
B212002002	16x2 - 200m
B212004001	20x2 - 100m
B212005001	26x3 - 50m

2.



Țeavă MultiSkin 4 izolată, izolație de 6 mm

3. Colac, conductivitate termică 0.040 W/m.K

B131001001 ●	14 x 2 - 100m - 6mm
B131002001 ●	16 x 2 - 100m - 6mm
B131004001 ●	20 x 2 - 50 m - 6mm
B131005002 ●	26 x 3 - 50 m - 6mm
B132001001 ●	14 x 2 - 100m - 6mm
B132002001 ●	16 x 2 - 100m - 6mm
B132004001 ●	20 x 2 - 50m - 6mm
B132005002 ●	26 x 3 - 50m - 6mm

● Tub albastru ● Tub roșu

3.



Țeavă MultiSkin 2 izolată, izolație de 6 mm

3. Colac, hōvezetési tényezō 0.040 W/m.K

B231002001	●	16x2 - 50m - 6mm
B231002002	●	16x2 - 100m - 6mm
B231004001	●	20x2 - 50m - 6mm
B231005001	●	26x3 - 25m - 6mm
B232002001	●	16x2 - 50m - 6mm
B232002002	●	16x2 - 100m - 6mm
B232004001	●	20x2 - 50m - 6mm
B232005001	●	26x3 - 25m - 6mm

● Tub albastru ● Tub roșu

3.



Țeavă MultiSkin 4 în tub de protecție

4. Colac

B121001003 ●	14 x 2 - 100m
B121002002 ●	16 x 2 - 50m
B121002003 ●	16 x 2 - 100m
B121004002 ●	20 x 2 - 50m
B121005001 ●	26 x 3 - 50m
B122001003 ●	14 x 2 - 100m
B122002002 ●	16 x 2 - 50m
B122002003 ●	16 x 2 - 100m
B122004002 ●	20 x 2 - 50m
B122005001 ●	26 x 3 - 50m

4.

● Tub albastru ● Tub roșu



Țeavă MultiSkin 2 în tub de protecție

4. Colac

B221003001 ●	16x2 - 50m
B221001001 ●	16x2 - 100m
B221004001 ●	20x2 - 50m
B221005001 ●	26x3 - 50m
B222003001 ●	16x2 - 50m
B222001001 ●	16x2 - 100m
B222004001 ●	20x2 - 50m
B222005001 ●	26x3 - 50m

4.

● Tub albastru ● Tub roșu



Scule și accesorii pentru sistemul multistrat

5. Mâner MultiSkin

112H Mâner pentru sculă de calibrare tip 112



5.

6. Sculă de calibrare MultiSkin, tip 112

11214 14 x 2

11216 16 x 2

11218 18 x 2

11220 20 x 2

11226 26 x 3

112KIT 16, 20, 26

6.



7. Sculă triplă de calibrare MultiSkin (3 dimensiuni)

S120162026 16, 20, 26mm

7.



8. Sculă manuală de îndoit țevi

R154016 16 x 2

R154020 20 x 2

9. Tăietor țevă

V390000

10. Dop pentru proba de presiune pentru țevi multistrat

11316 16 x 2

11320 20 x 2

11326 26 x 3

8.



9.



10.



11. Arc de îndoit țevă multistrat

Interior	MB3610	14 x 2
Interior	MB3620	16 x 2
Interior	MB3620L	16 x 2
Interior	MB3630	18 x 2
Interior	MB3640	20 x 2
Interior	MB3650	26 x 3
Exterior	C210002001	14 x 2
Exterior	C210003001	16 x 2
Exterior	C210005001	20 x 2

11. Interior



Exterior



10 ANI GARANȚIE



Sistemele executate cu țevi și fittinguri multistrat COMAP MultiSkin au garanție de 10 ani.

Pentru mai multe informații cu privire la aplicarea garanției consultați termenii și condițiile de garanție COMAP.

COMAP

Pentru mai multe informații despre
gama completă de produse **MultiSkin**
contactați consultantul
dumneavoastră COMAP.

COMAP HUNGÁRIA KFT.

2040 Budaörs

Gyár u. 2.

www.comap.eu

www.comap.ro

www.aalberts.nl

